

**Mini (7/8) 3 pole, Male (Ext.) 90°/Female 90° ,**

PVC, STOOW, 3x16AWG, yellow, 7.5m

Male 90° – female 90°

7/8" – 7/8", 3-pole

Power cable

USA

Further cable lengths on request.

Plastic housings with good resistance against chemicals and oils.

The resistance to aggressive media should be individually tested for your application. Further details on request.

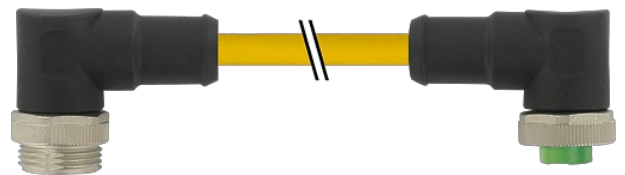
**[Link to Product](#)****Illustration**

Product may differ from Image

**Approvals**

\* only for products with UL/CSA approved cable

**Form**

Form A3A31

**General data**

Temperature range -25...+80 °C, depending on cable quality

**Cables**

Cable number	UBB
No./diameter of wires	3x 1.5 mm <sup>2</sup>
Construction (core)	approx. 3.1 mm
Wire isolation	PVC (bk, gn, wh)
Jacket Color	yellow
Material (jacket)	PVC (UL/CSA)
Outer Ø	10.0 mm ±5%
Bend radius (fixed)	10x outer Ø
Bend radius (moving)	15x outer Ø
Temperature range (fixed)	-50...+105 °C
Temperature range (mobile)	-20...+90 °C

**Technical Data**

Operating voltage	max. 600 V AC/DC
Operating current per contact	max. 12 A
Locking of ports	Screw thread 7/8" (recommended torque 1.5 Nm) self-securing
Compression gland	7/8" (SW24)
Protection	IP68 inserted and tightened (EN 60529)

Locking material	Zinc die casting, matte nickel plated
Material	PUR

**Commercial data**

customs tariff number	85444290
EAN	4048879634380
Packaging unit	1

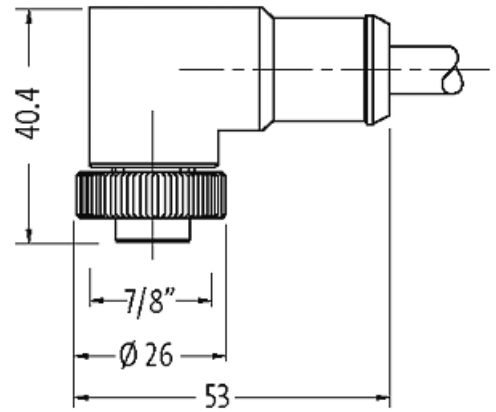
**Sketch**

Product may differ from Image